

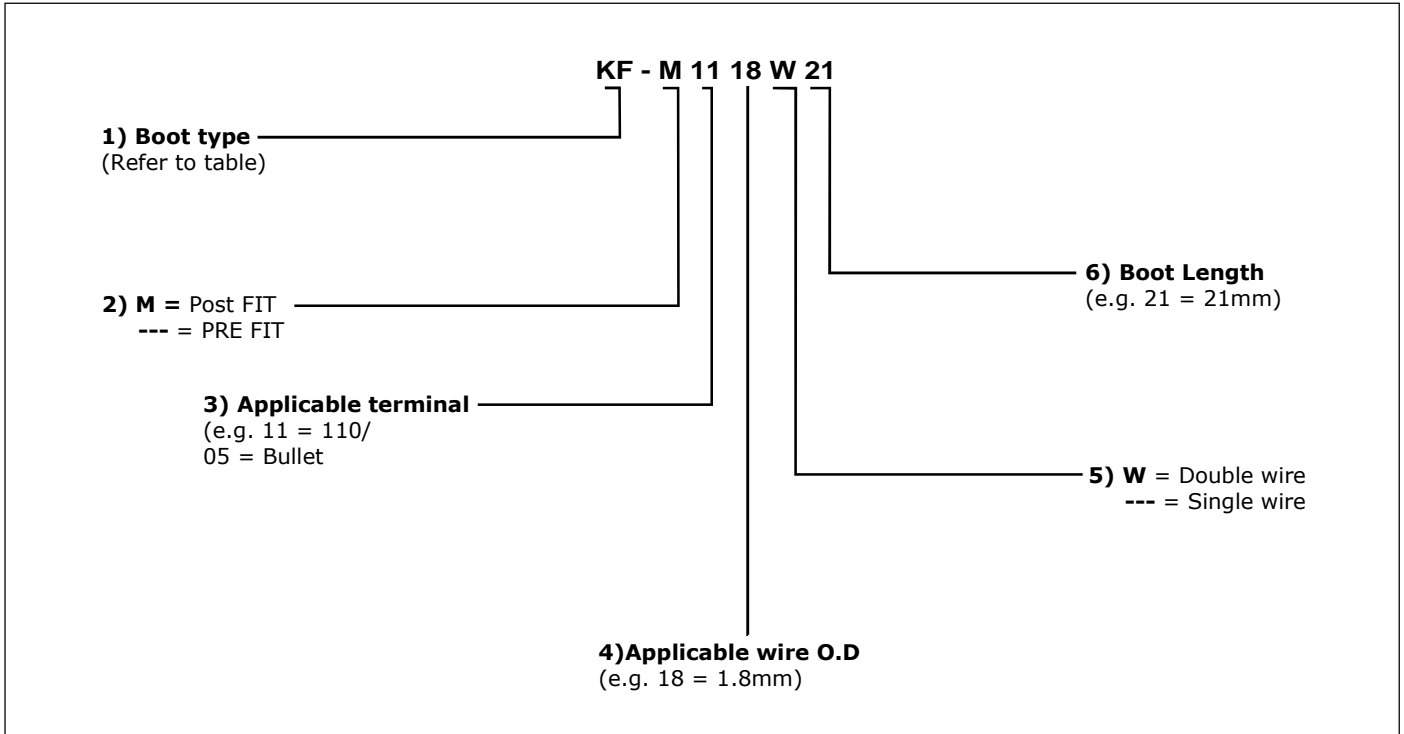

# INSULATION SLEEVES

## Model number identification



### Boot Type

Part Name	KF/KFH/KFO	KFF/KFFH/KFFO	KP/KPH/KPO	KS/KSH/KSO
Applicable Terminals	STRAIGHT Terminals (e.g. STO)	FLAG Terminals (e.g. SFO)	MALE BULLET Terminals (e.g. SGM)	FEMALE BULLET Terminals (e.g. SGF)

### Material Data

Part Name	KF/KFF/KS/KP	KFH/KFFH/KSH/KPH	KFO/KFFO/KSO/KPO
Material Type	PVC SH-108VT	PVC X-731TJ	PVC No. 4
Burn Rate	JIS K7201	UL94V-2	UL94V-0
Max. Voltage Rating	300 V	600 V	600 V
Temperature Range	-40℃ ~ 60℃	-30℃ ~ 105℃	-30℃ ~ 60℃
Max. Voltage	17.1 KV	13.7 KV	25.8 KV
Durability (10KV)	3.00 Seconds	3.00 Seconds	12.00 Seconds
Max. Elongation	400%	310%	220%
Harness (Durometer A Type)	63 ~ 65	63 ~ 65	67 ~ 70
UL Card No.	E64155 (S)	E64155 (S)	E64155 (S)



# INSULATION SLEEVES

## Straight Type <KF-110 Version>

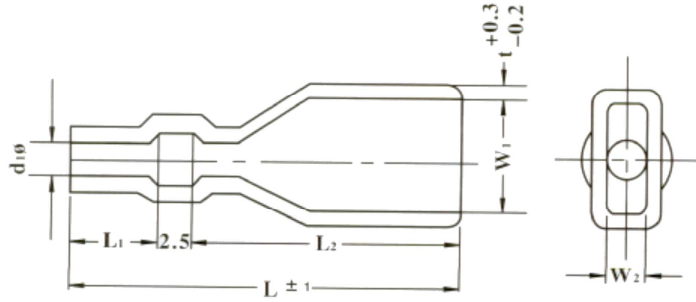

E64155 (S)

Model No.	Dimensions(mm)							Wire O.D. (mm)
	d10	L1	L2	L+/-1	W1	W2	T +0.3/-0.2	
KF-111621	1.6	5	13.5	21	4	2.1	0.8	~
KF-111821	1.8	5	13.5	21	4	2.1	0.8	1.5~1.7mm
KF-112521	2.5	5	13.5	21	4	2.1	0.8	1.8~2.4mm
KF-112821	2.8	5	13.5	21	4	2.1	0.8	2.5~2.7mm
KF-113021	3.0	5	13.5	21	4	2.1	0.8	2.8~3.0mm
KF-1125W21	2.5	5	13.5	21	4	2.1	0.8	~

Note: 1) Delivery lead times may vary depending on the product. Contact JST for details, these products are ONLY available from the following JST affiliates; J.S.T. (U.K.) Ltd, J.S.T. Belgium N.V., J.S.T. India Liaison Office, and JST-SouthAfrica.com.  
 2) In line with a policy of continual product development, JST reserves the right to change the specifications of the goods described in the catalogue At any time and without prior notice.

## Straight Type <KF-187 Version>

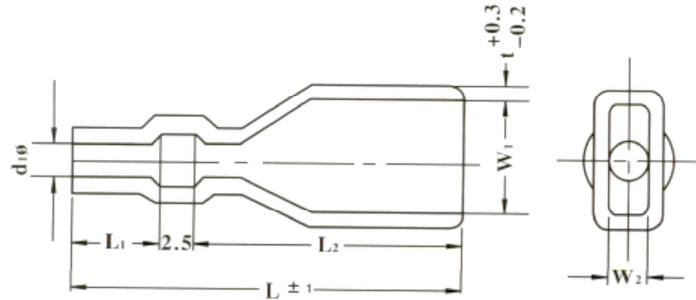

E64155 (S)

Model No.	Dimensions(mm)							Wire O.D. (mm)
	d10	L1	L2	L+/-1	W1	W2	T +0.3/-0.2	
KF-181823	1.8	5	15.5	23	5.7	2.3	1.0	1.5~1.7mm
KF-182223	2.2	5	15.5	23	5.7	2.3	1.0	~
KF-182523	2.5	5	15.5	23	5.7	2.3	1.0	1.7~2.4mm
KF-182823	2.8	5	15.5	23	5.7	2.3	1.0	2.5~2.7mm
KF-183023	3.0	5	15.5	23	5.7	2.3	1.0	2.8~2.9mm
KF-183523	3.5	5	15.5	23	5.7	2.3	1.0	3.0~3.4mm
KF-184023	4.0	5	15.5	23	5.7	2.3	1.0	3.5~3.9mm
KF-184523	4.5	5	15.5	23	5.7	2.3	1.0	4.1~4.4mm
KF-1832W23	3.2	5	15.5	23	5.7	2.3	1.0	~

Note: 1) Delivery lead times may vary depending on the product. Contact JST for details, these products are ONLY available from the following JST affiliates; J.S.T. (U.K.) Ltd, J.S.T. Belgium N.V., J.S.T. India Liaison Office, and JST-SouthAfrica.com.  
 2) In line with a policy of continual product development, JST reserves the right to change the specifications of the goods described in the catalogue At any time and without prior notice.

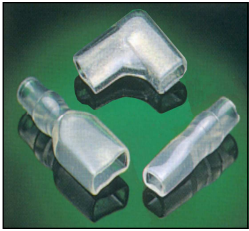

# INSULATION SLEEVES

## Straight Type <KF-205 Version>

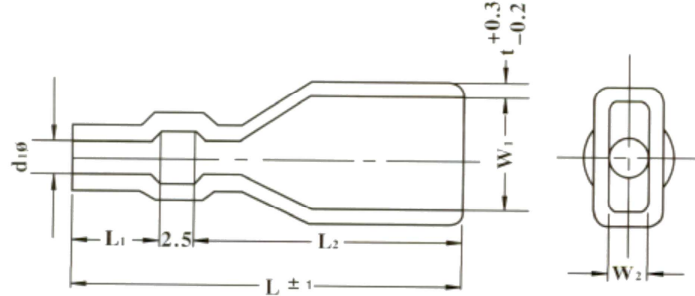

E64155 (S)

Model No.	Dimensions(mm)							Wire O.D. (mm)
	d1Ø	L1	L2	L+/-1	W1	W2	T +0.3/-0.2	
KF-202523	2.5	5	15.5	23	6.5	3.0	1.0	2.0~2.4mm
KF-203223	3.2	5	15.5	23	6.5	3.0	1.0	2.5~3.1mm
KF-2025W23	2.5	5	15.5	23	6.5	3.0	1.0	~

Note: 1) Delivery lead times may vary depending on the product. Contact JST for details, these products are ONLY available from the following JST affiliates; J.S.T. (U.K.) Ltd, J.S.T. Belgium N.V., J.S.T. India Liaison Office, and JST-SouthAfrica.com.  
2) In line with a policy of continual product development, JST reserves the right to change the specifications of the goods described in the catalogue At any time and without prior notice.

## Straight Type <KF-250 Version>

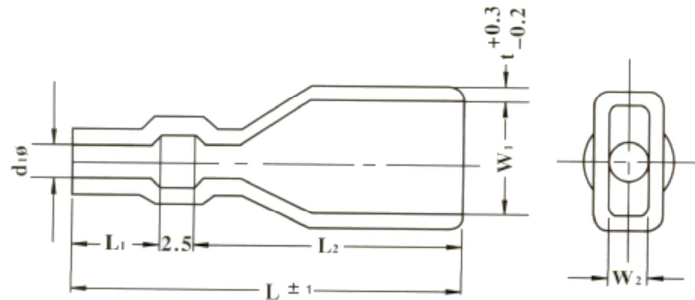
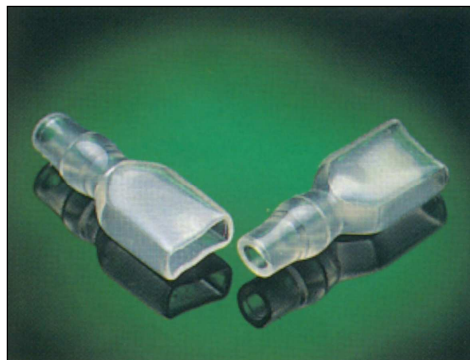

E64155 (S)

Model No.	Dimensions(mm)							Wire O.D. (mm)
	d1Ø	L1	L2	L+/-1	W1	W2	T +0.3/-0.2	
KF-252024	2.0	5	16.5	24	8	3.5	1.0	1.6~1.9mm
KF-252524	2.5	5	16.5	24	8	3.5	1.0	2.0~2.4mm
KF-252824	2.8	5	16.5	24	8	3.5	1.0	2.5~2.7mm
KF-253024	3.0	5	16.5	24	8	3.5	1.0	2.7~2.9mm
KF-253224	3.2	5	16.5	24	8	3.5	1.0	2.9~3.1mm
KF-253525	3.5	5	17.5	25	8	3.5	1.0	3.1~3.4mm
KF-253825	3.8	5	17.5	25	8	3.5	1.0	3.5~3.7mm
KF-254025	4.0	5	17.5	25	8	3.5	1.0	3.7~3.9mm
KF-254525	4.5	5	17.5	25	8	3.5	1.0	4.0~4.4mm
KF-254825	4.8	5	17.5	25	8	3.5	1.0	4.5~4.7mm
KF-255025	5.0	5	17.5	25	8	3.5	1.0	4.7~4.9mm
KF-256027	6.0	5	17.5	27	8	3.5	1.0	5.0~5.8mm <sup>2</sup>
KF-2525W24	2.5	5	16.5	24	8	3.5	1.0	~
KF-2532W24	3.2	5	16.5	24	8	3.5	1.0	~

Note: 1) Delivery lead times may vary depending on the product. Contact JST for details, these products are ONLY available from the following JST affiliates; J.S.T. (U.K.) Ltd, J.S.T. Belgium N.V., J.S.T. India Liaison Office, and JST-SouthAfrica.com.  
2) In line with a policy of continual product development, JST reserves the right to change the specifications of the goods described in the catalogue At any time and without prior notice.